

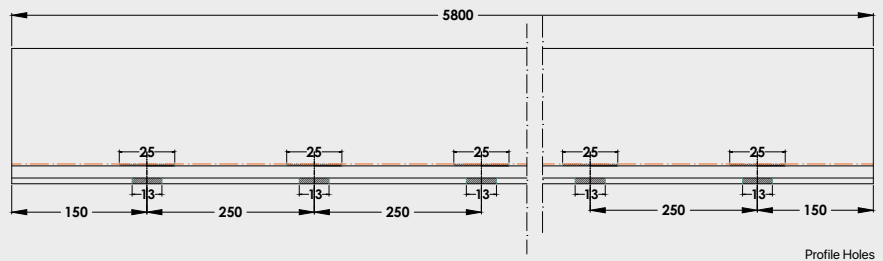

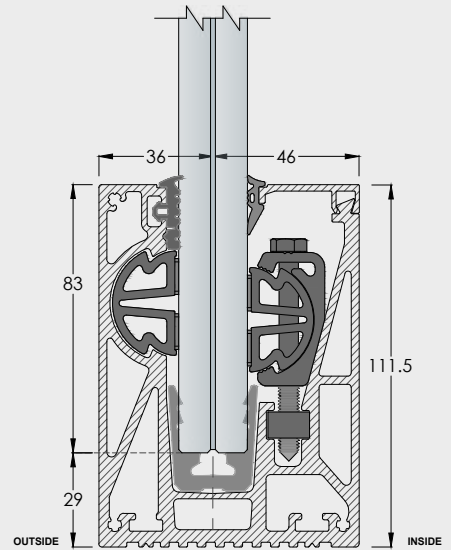

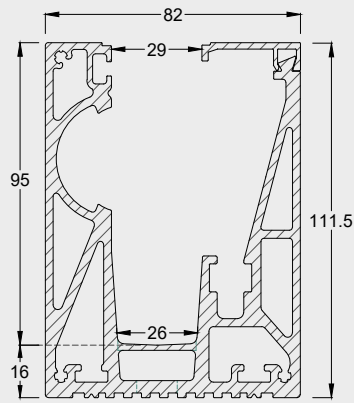





M10 | RAILING BASE



Profile data							
Product Code	Material	Finish	Length (mm)	Weight (kg/m)	Max Height (m)	Max Load (KN)	Glass Thickness
GM10	Aluminium	Satin	5800	5,640	1,1	1	21,52
GM10	Aluminium	Natural Anodize	5800	5,640	1,1	1	21,52

System components						
21,52	Glass Thickness	GM10-20A 	GM10-20B 	GM01-20C 	GM10-5 	

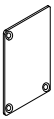
Sets/bar					
					
Length: 6m	Length: 6m	Length: 6m	24 pieces	23 pieces	GM10EC (OPTIONAL)
30m Roll Unit		14m Roll Unit			

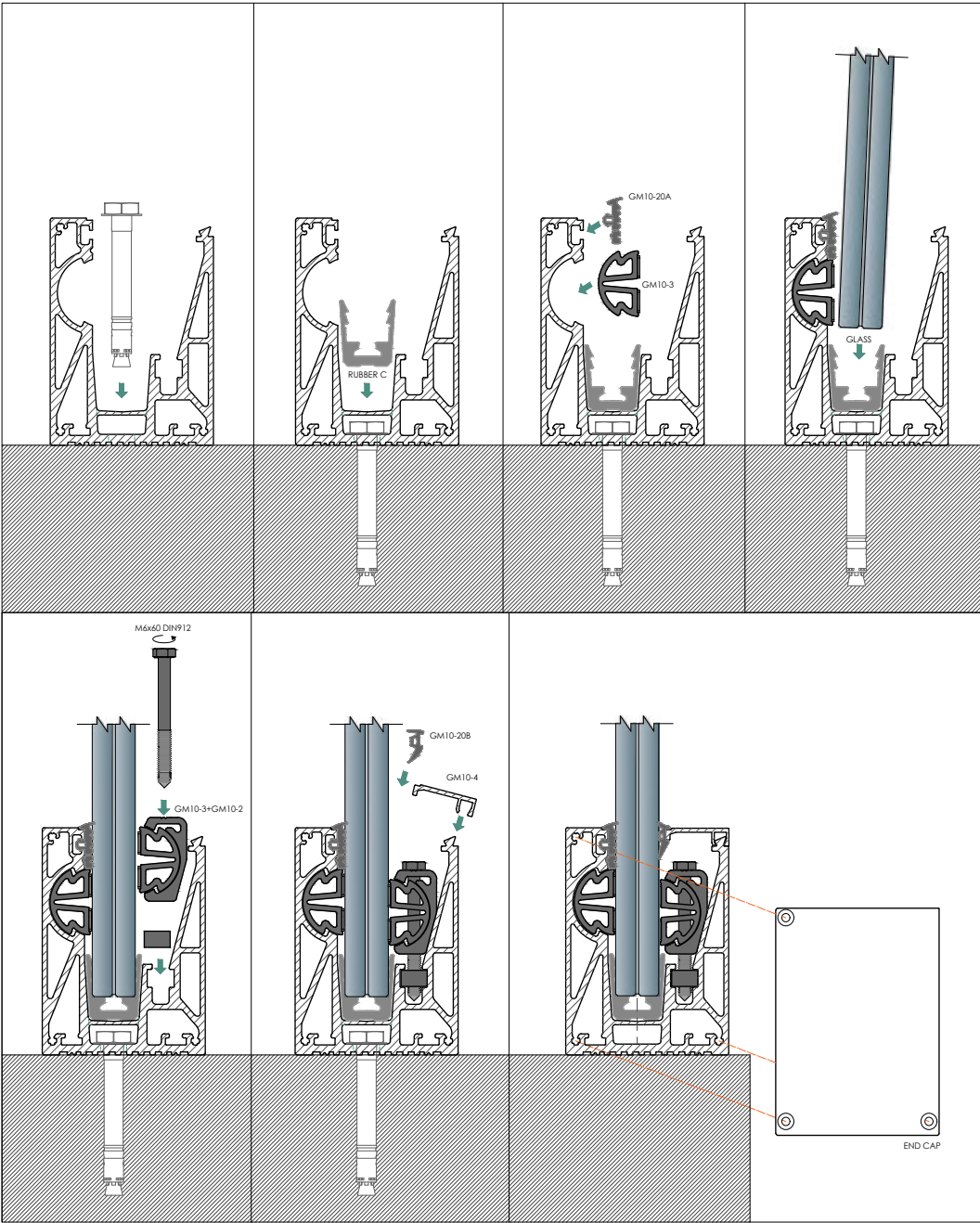

M10

GM10
TOP MOUNTED