

M18 | RAILING BASE

NEW

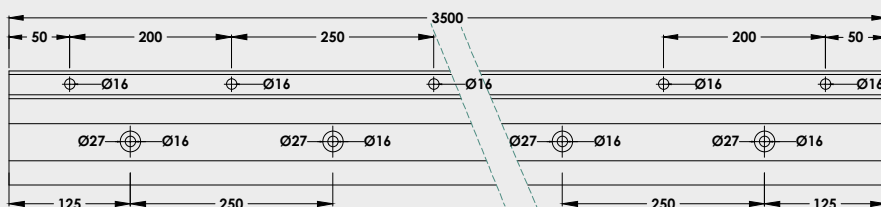

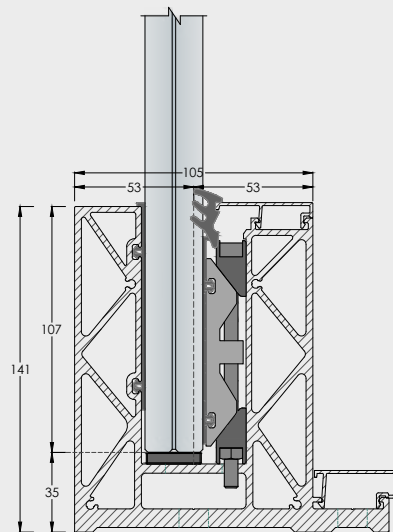

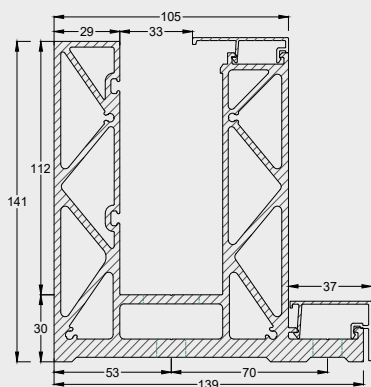





Profile Holes





Profile data

Product Code	Material	Finish	Length (mm)	Weight (kg/m)	Max Height (m)	Max Load (KN)	Glass Thickness
GM12	Aluminium	Satin	3500	11,163	1,2	3	21,52 - 25,52
GM12	Aluminium	Natural Anodize	3500	11,163	1,2	3	21,52 - 25,52

System components

21,52	Glass Thickness					
		GM12-24	GM12-20	GM01-12B	5mm adjustment block	GM12-5
25,52	Glass Thickness					
		GM12-24		GM01-16B	5mm adjustment block	GM12-5

Sets/bar

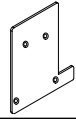
						
Length: 3500	Length: 3500	Length: 3500	8 pieces	12 pieces	29 pieces	GM12EC (OPTIONAL)
30m Roll Unit						

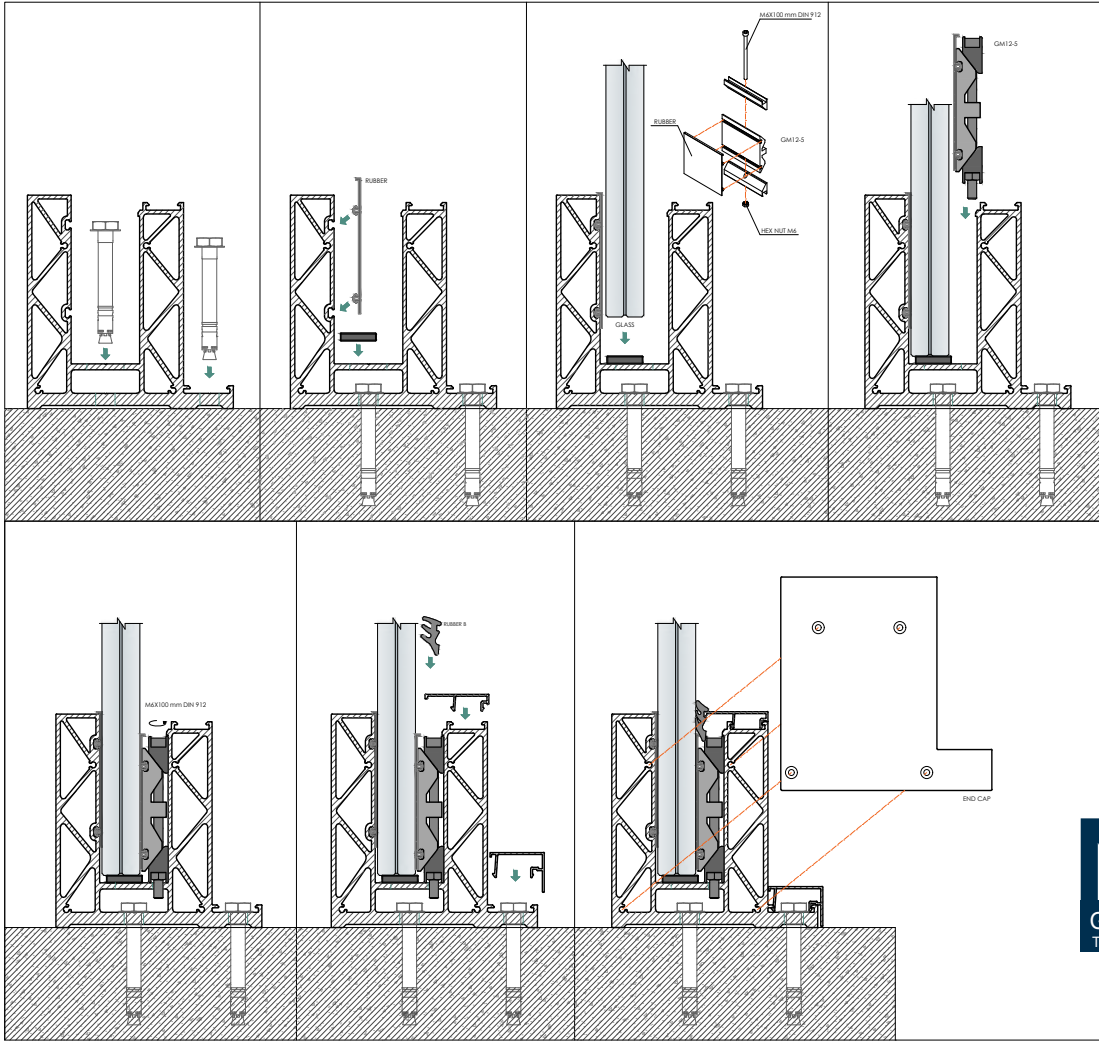

M18

GM12
TOP MOUNTED

3 kN MAXIMUM LOAD

